

# DUO 100

## Plano

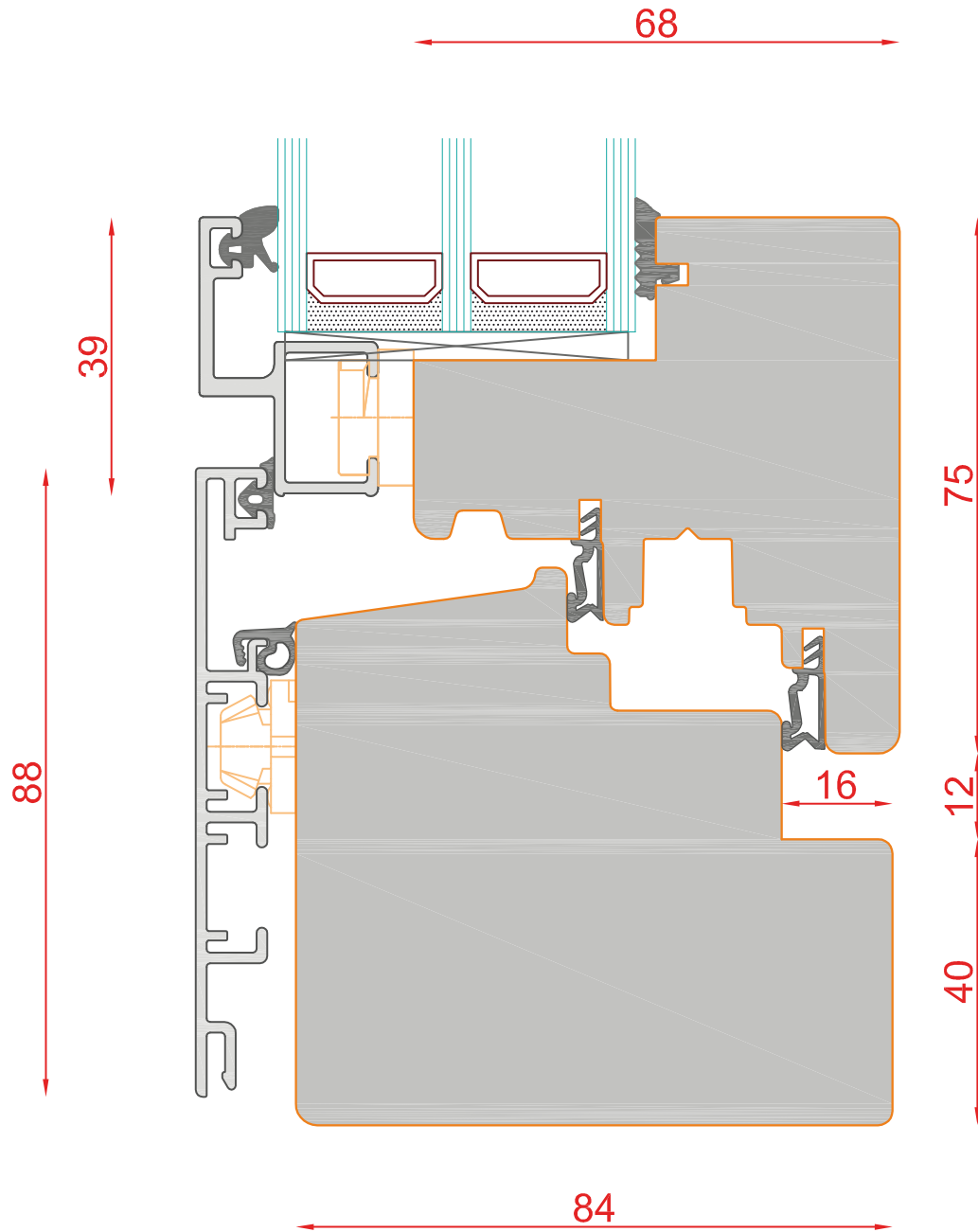
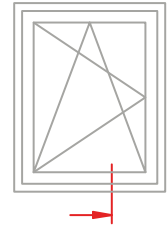

**DUO 100**  
PLANO

Schnitt : Vertikal unten

Typ: DK

| Seite: 213

**SCHMIDT VISBEK**  
Fenster. Türen. Innovationen.

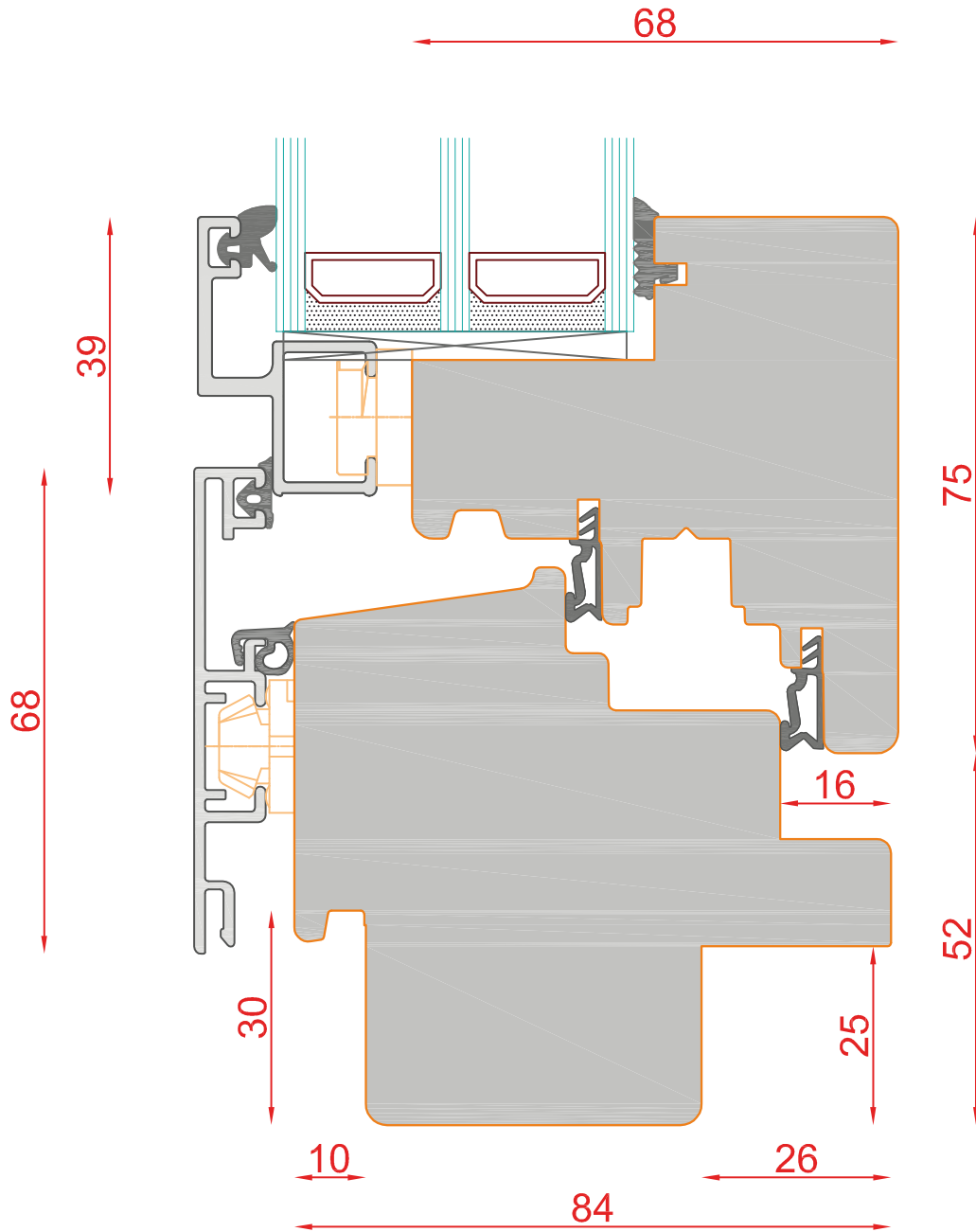
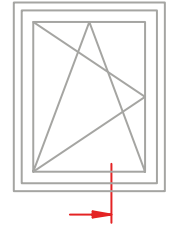

**DUO 100**  
PLANO

Schnitt : Vertikal unten

Typ: DK mit Fensterbankfalz | Seite: 214

**SCHMIDT VISBEK**  
Fenster. Türen. Innovationen.



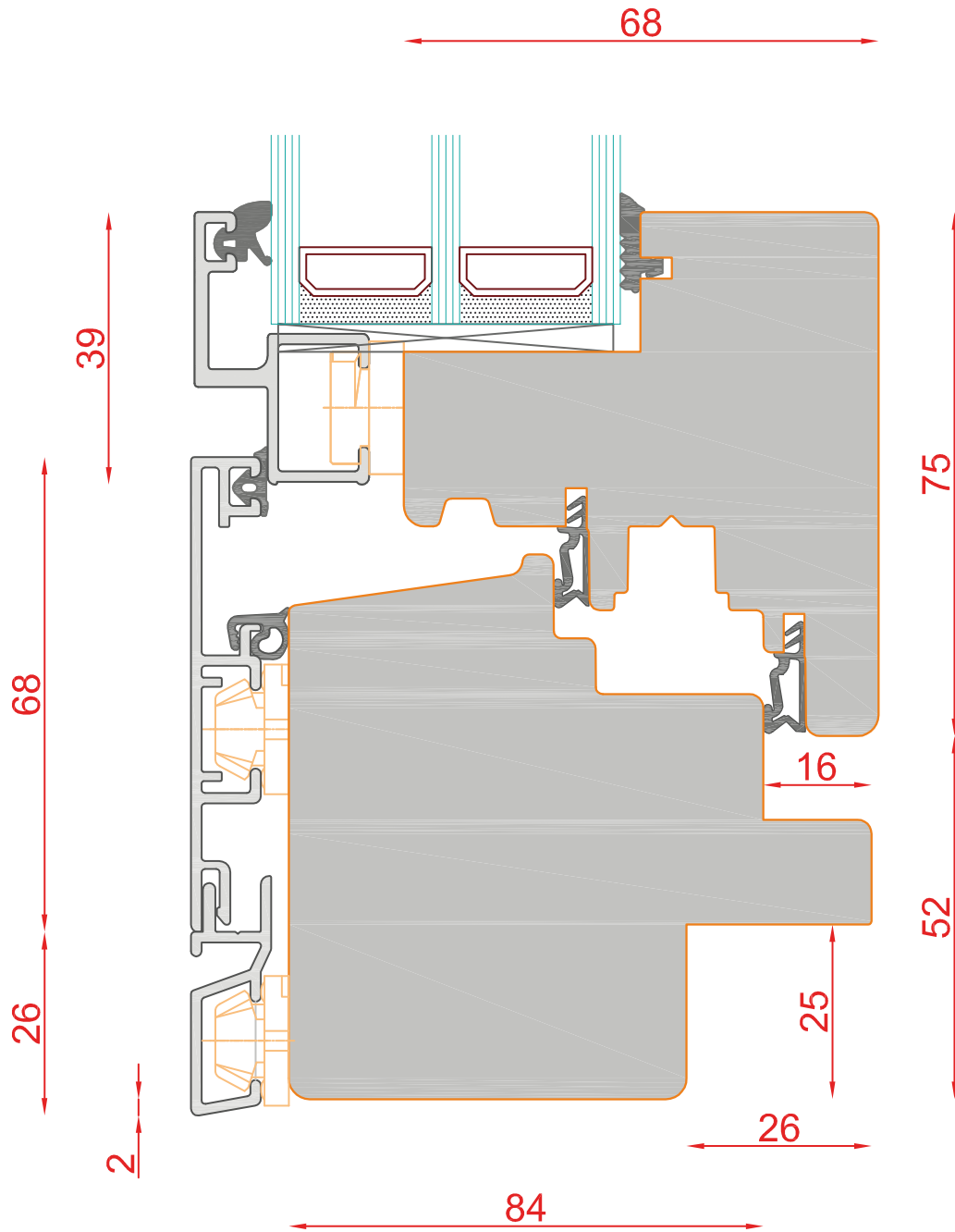
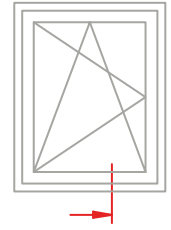

**DUO 100**  
PLANO

Schnitt : Vertikal unten

Typ: DK mit Steinbankanschluss | Seite: 215

**SCHMIDT VISBEK**  
Fenster. Türen. Innovationen.

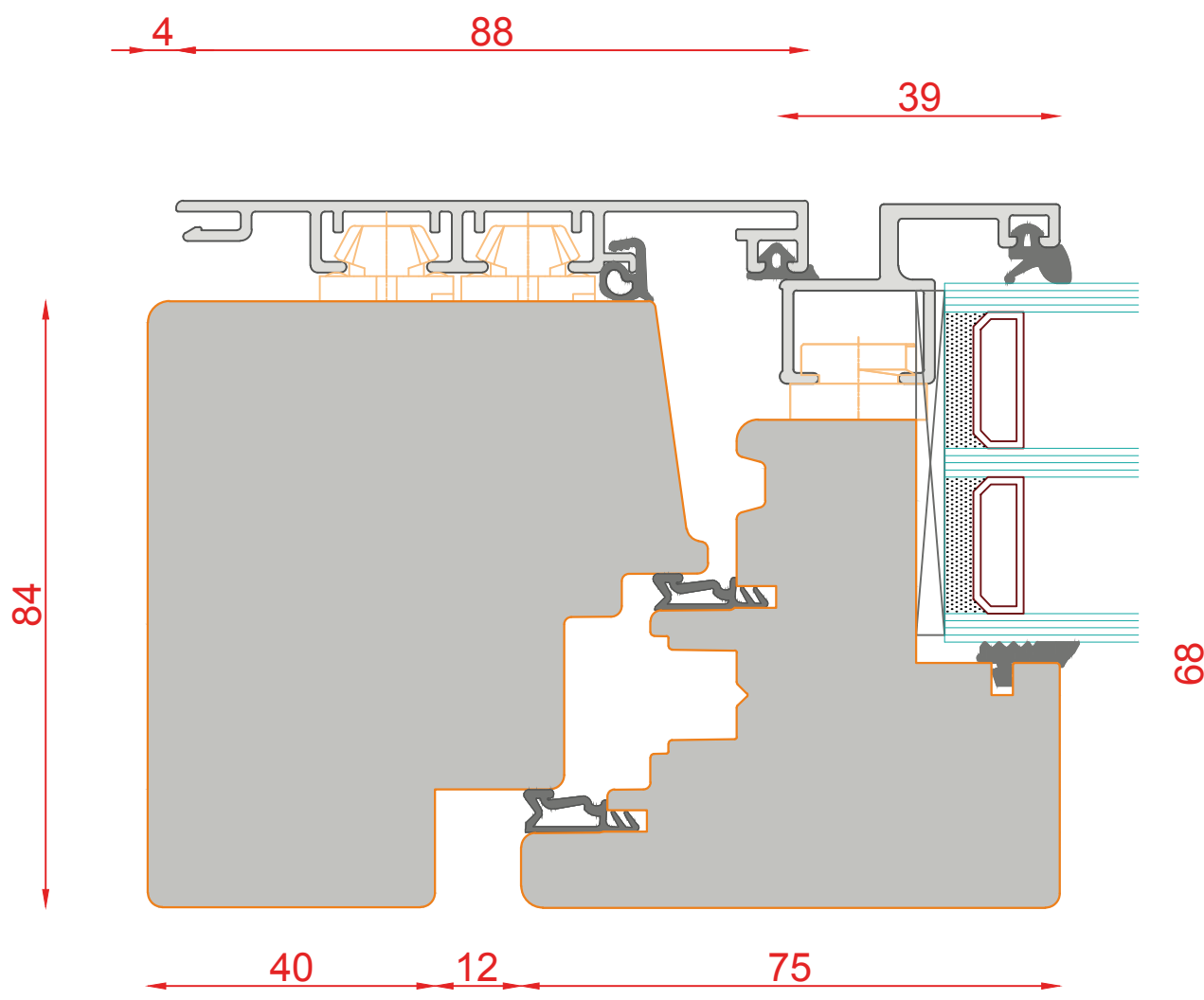
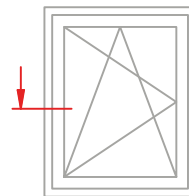

**DUO 100**  
PLANO

Schnitt : Horizontal seitlich und oben

Typ: DK

| Seite: 216

**SCHMIDT VISBEK**  
Fenster, Türen, Innenelemente

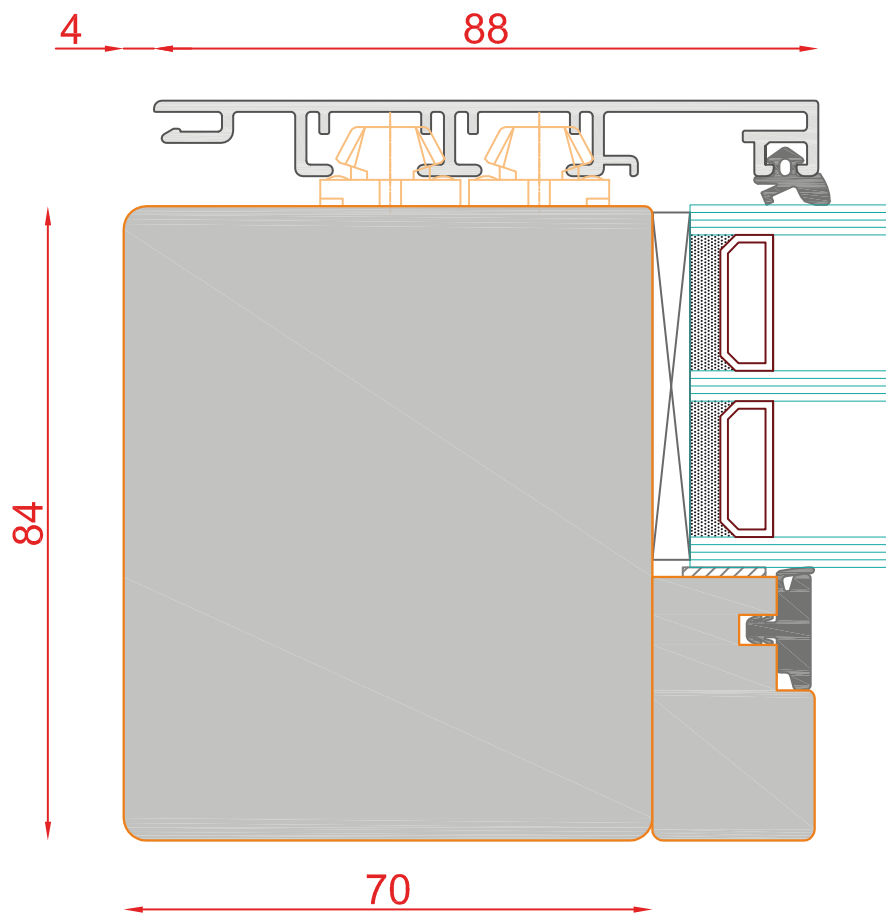
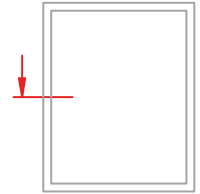

**DUO 100**  
PLANO

Schnitt : Horizontal seitlich und oben

Typ: FiB

| Seite: 217

**SCHMIDT VISBEK**  
Fenster. Türen. Innovationen.

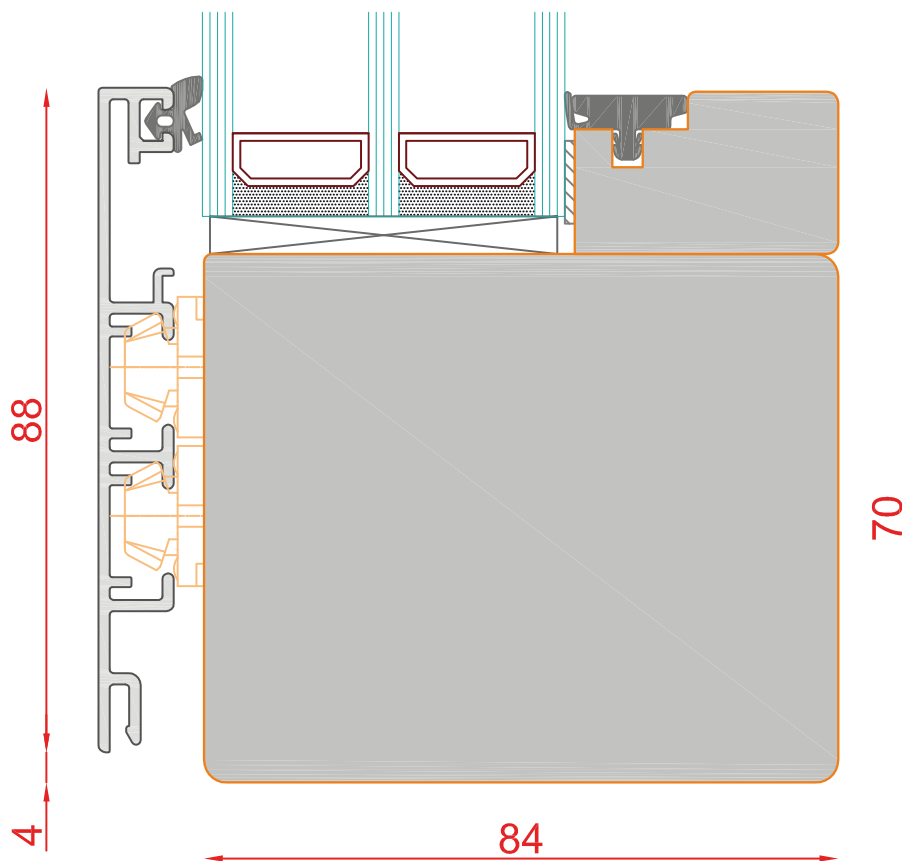
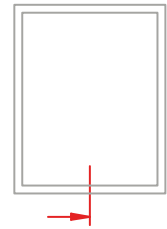

DUO 100  
PLANO

Schnitt : Vertikal unten

Typ: FIB

| Seite: 218

**SCHMIDT VISBEK**  
Fenster. Türen. Innovationen.

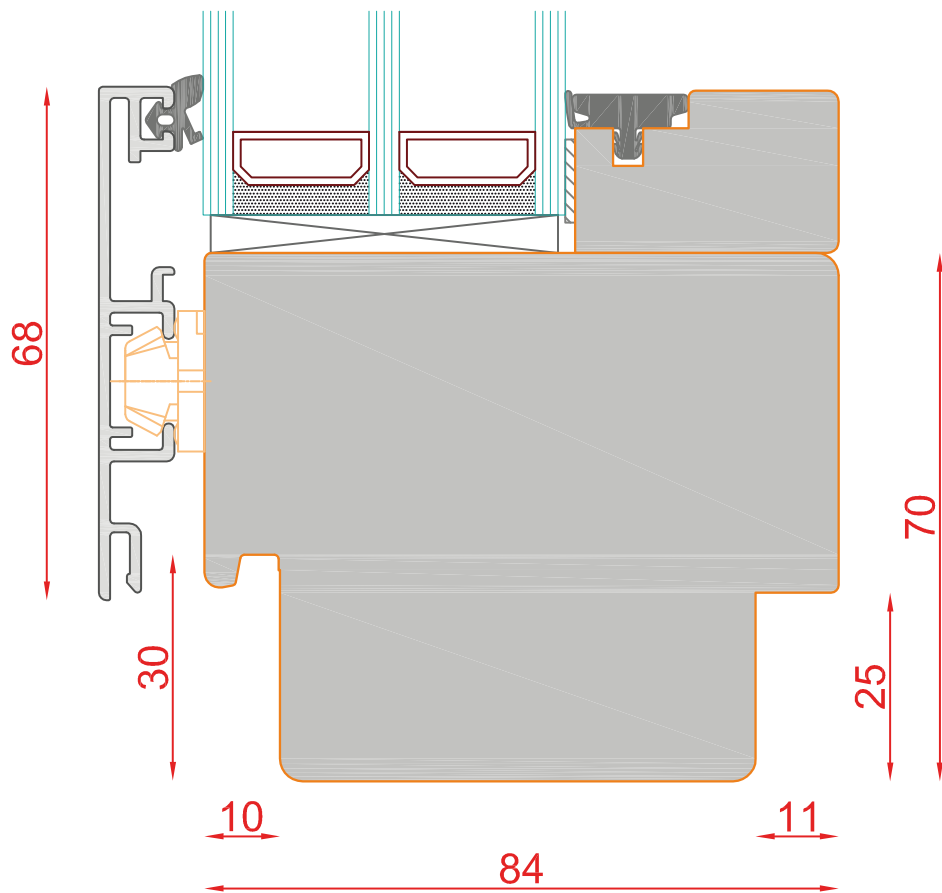
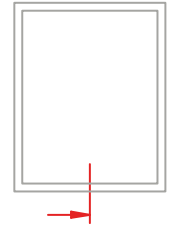

**DUO 100**  
PLANO

Schnitt : Vertikal unten

Typ: FiB

| Seite: 219

**SCHMIDT VISBEK**  
Fenster. Türen. Innovationen.



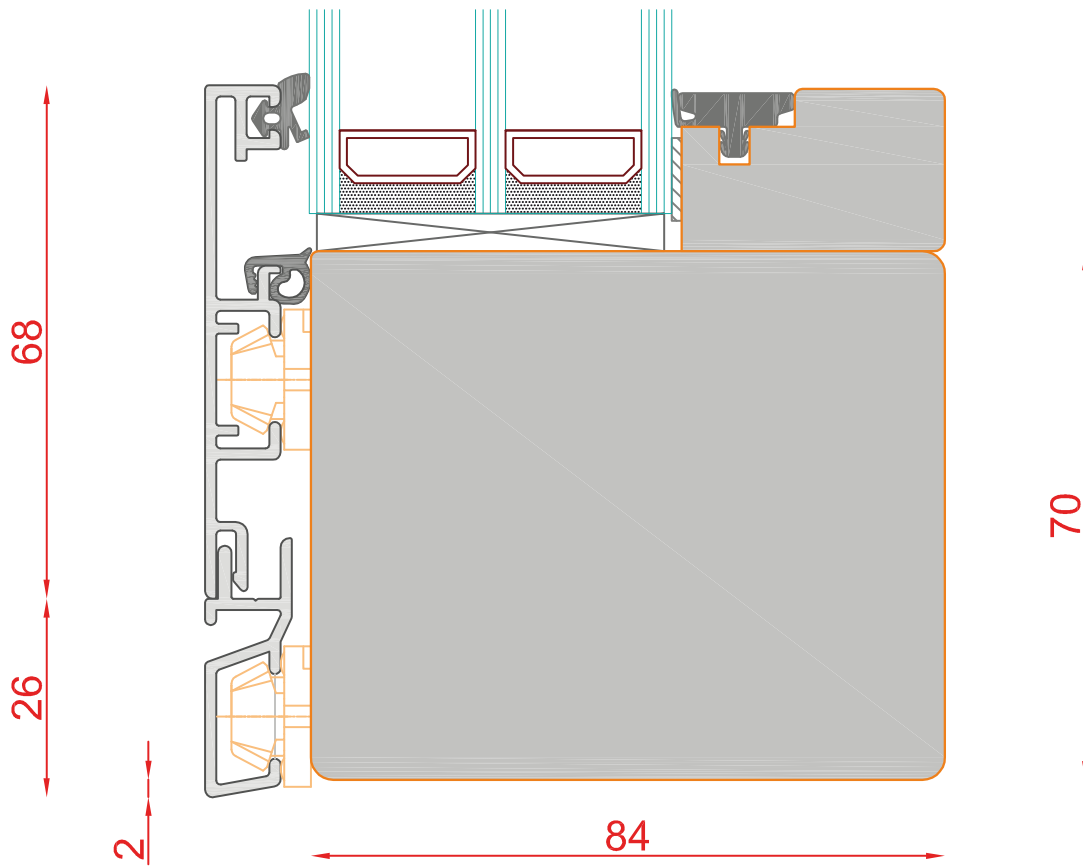
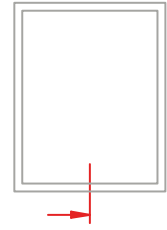

DUO 100  
PLANO

Schnitt : Vertikal unten

Typ: FiB

| Seite: 220

**SCHMIDT VISBEK**  
Fenster. Türen. Innovationen.



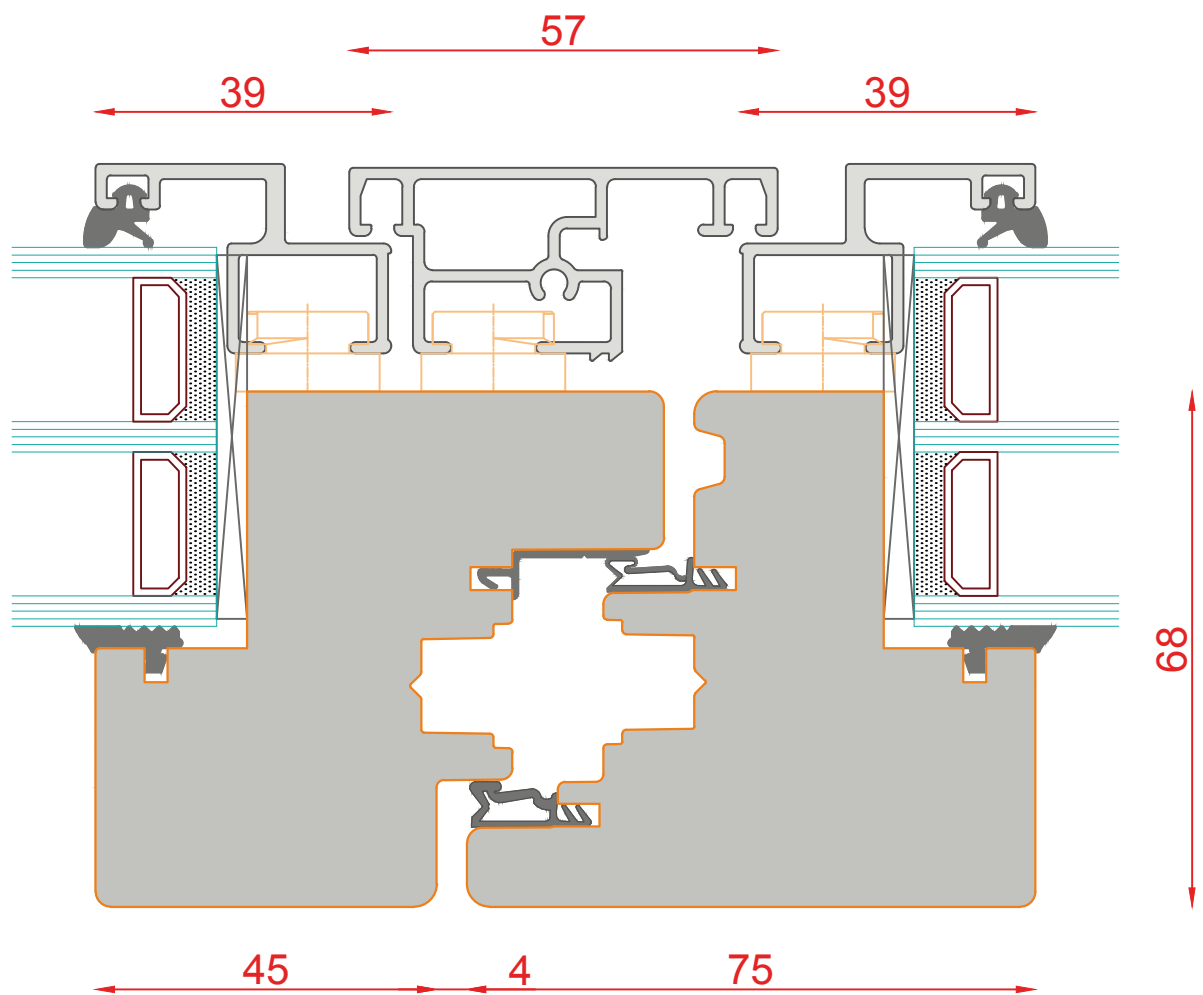
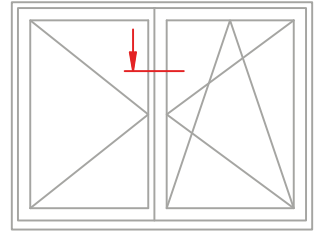

**DUO 100**  
PLANO

Schnitt : Horizontal Stulp

Typ: DK

| Seite: 221

**SCHMIDT VISBEK**  
Fenster Türen Innentüren

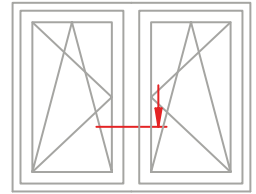
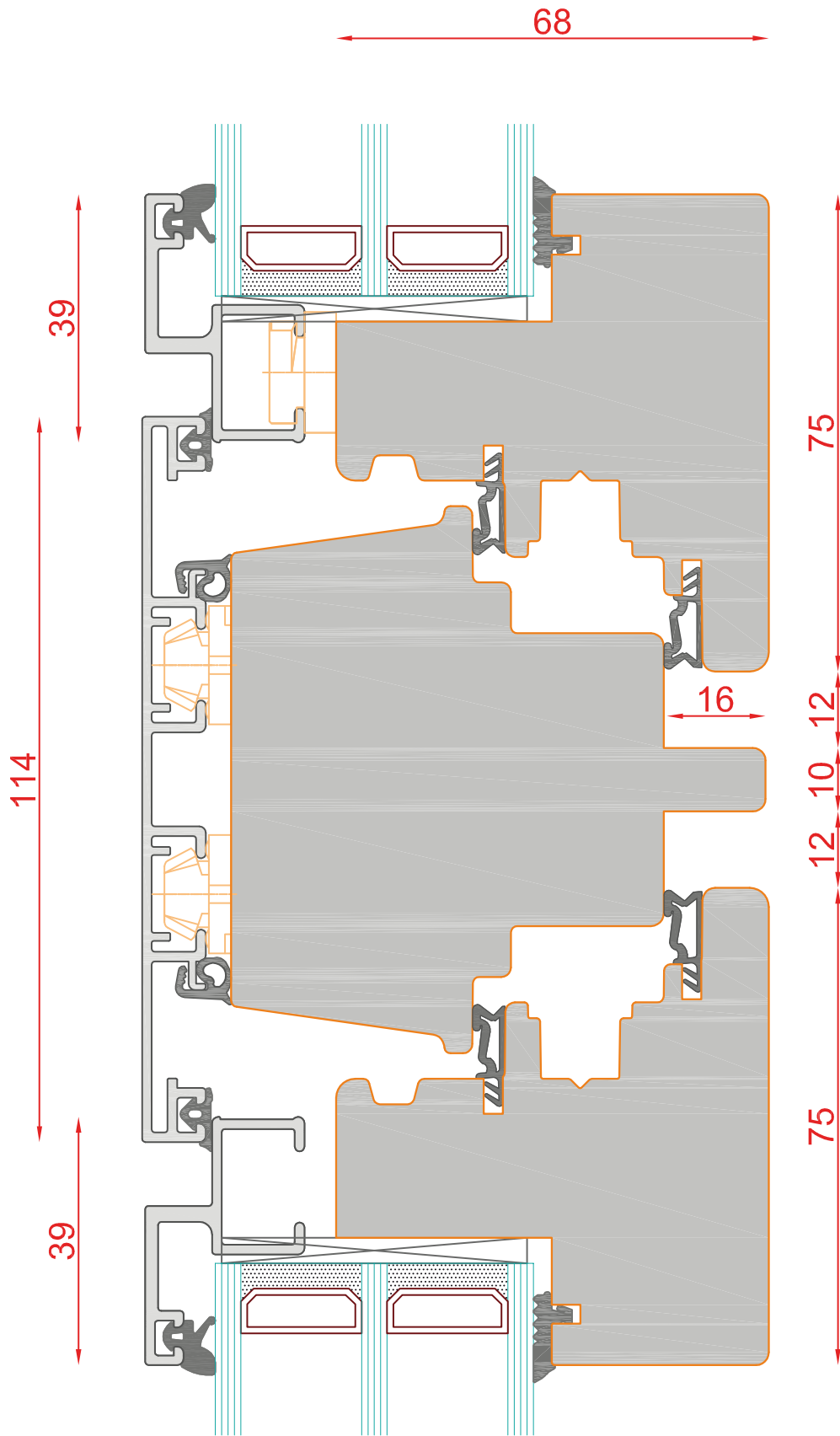

**DUO 100**  
PLANO

Schnitt : Horizontal Mitte Pfosten

Typ: DK mit Mittelpfosten

| Seite: 222

**SCHMIDT VISBEK**  
Fenster. Türen. Innovationen.

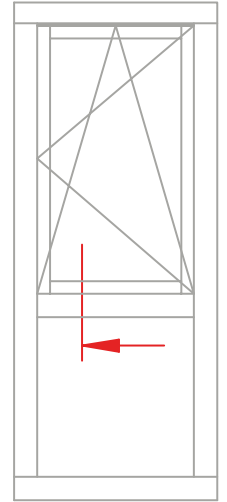
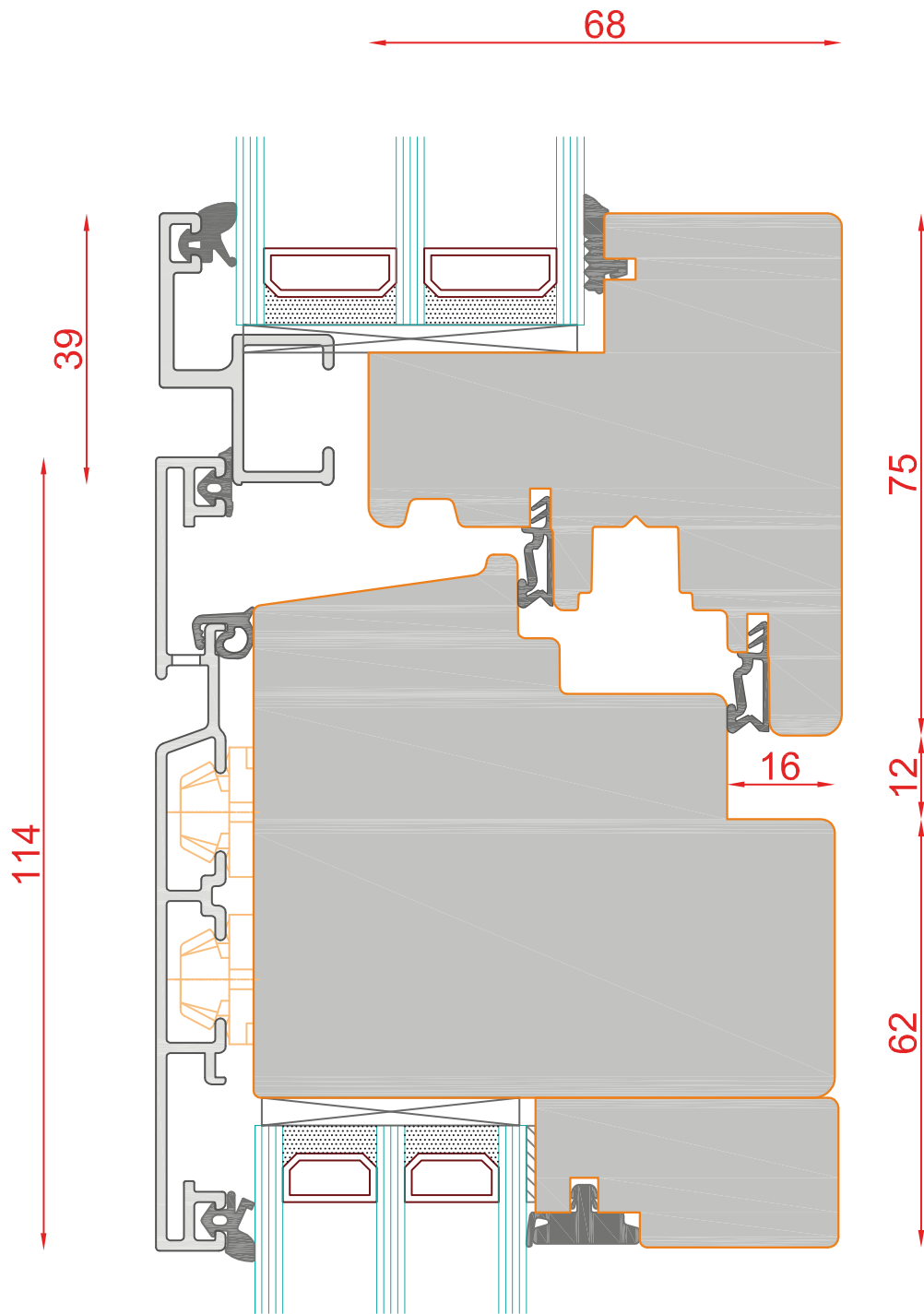

**DUO 100**  
PLANO

Schnitt : Vertikal Kämpfer DK-FiB

Typ: FiB

| Seite: 223

**SCHMIDT VISBEK**  
Fenster. Türen. Innovationen.



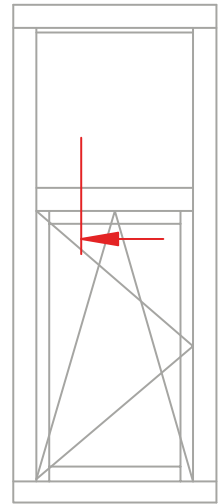
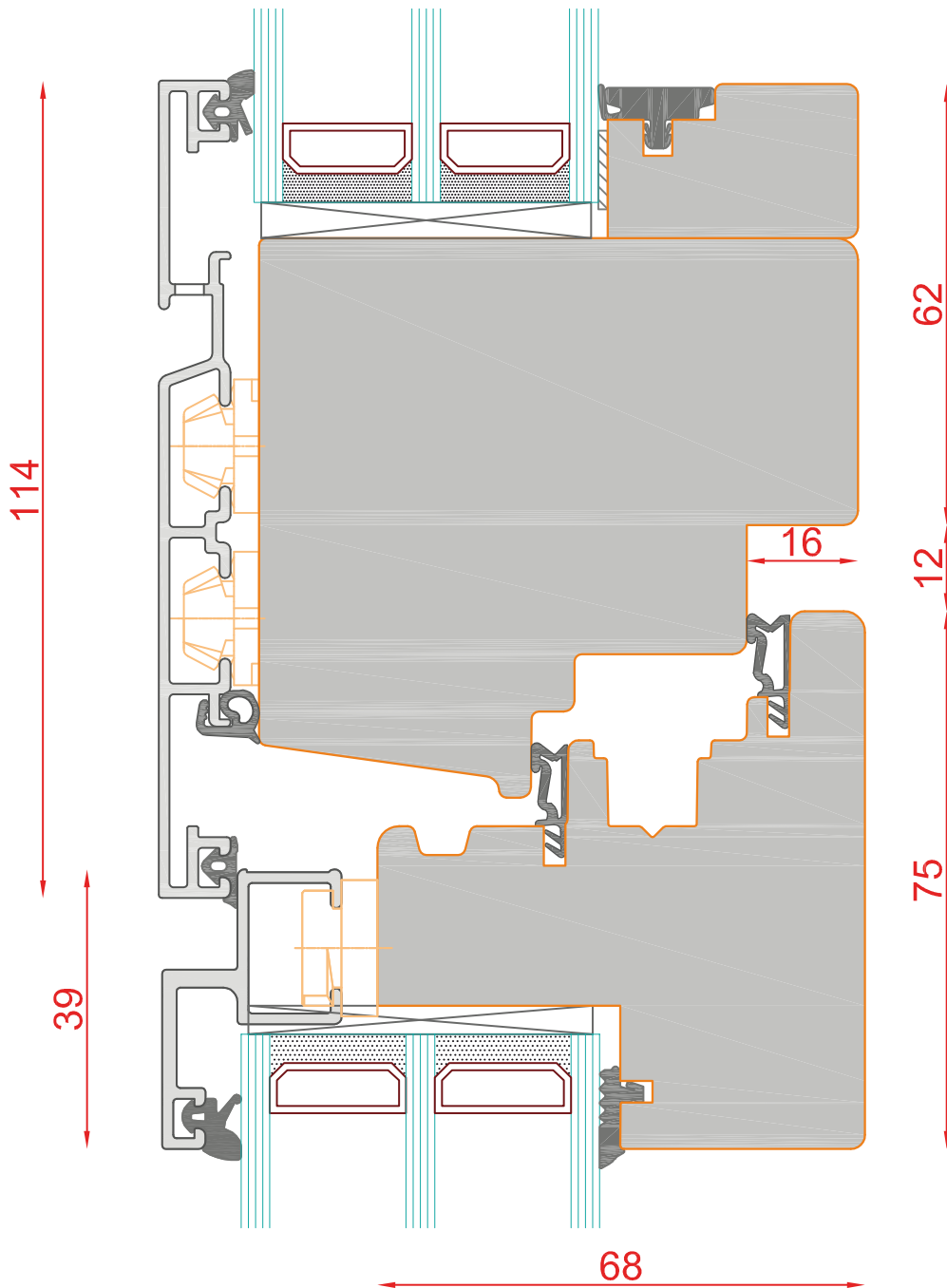

**DUO 100**  
PLANO

Schnitt : Vertikal Kämpfer DK-FIB

Typ: FiB

| Seite: 224

**SCHMIDT VISBEK**  
Fenster. Türen. Innovationen.

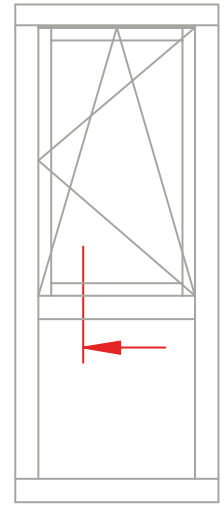
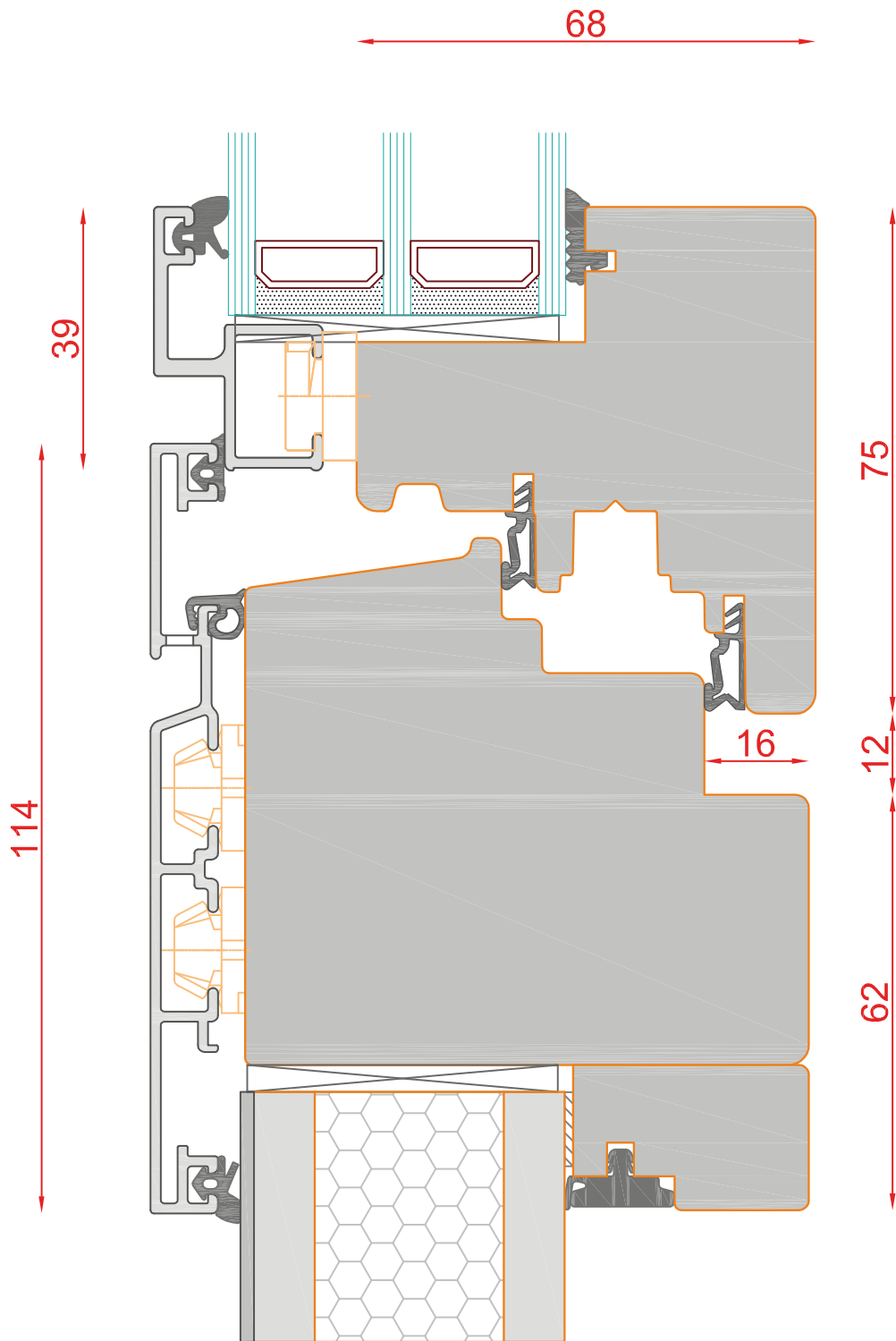

**DUO 100**  
PLANO

Schnitt : Vertikal Kämpfer DK-FIB

Typ: Füllung

| Seite: 225

**SCHMIDT VISBEK**  
Fenster. Türen. Innovationen.

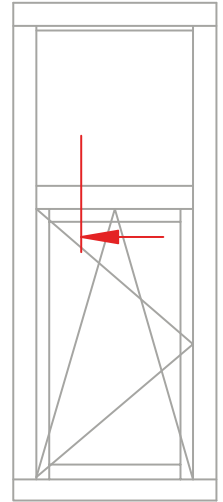
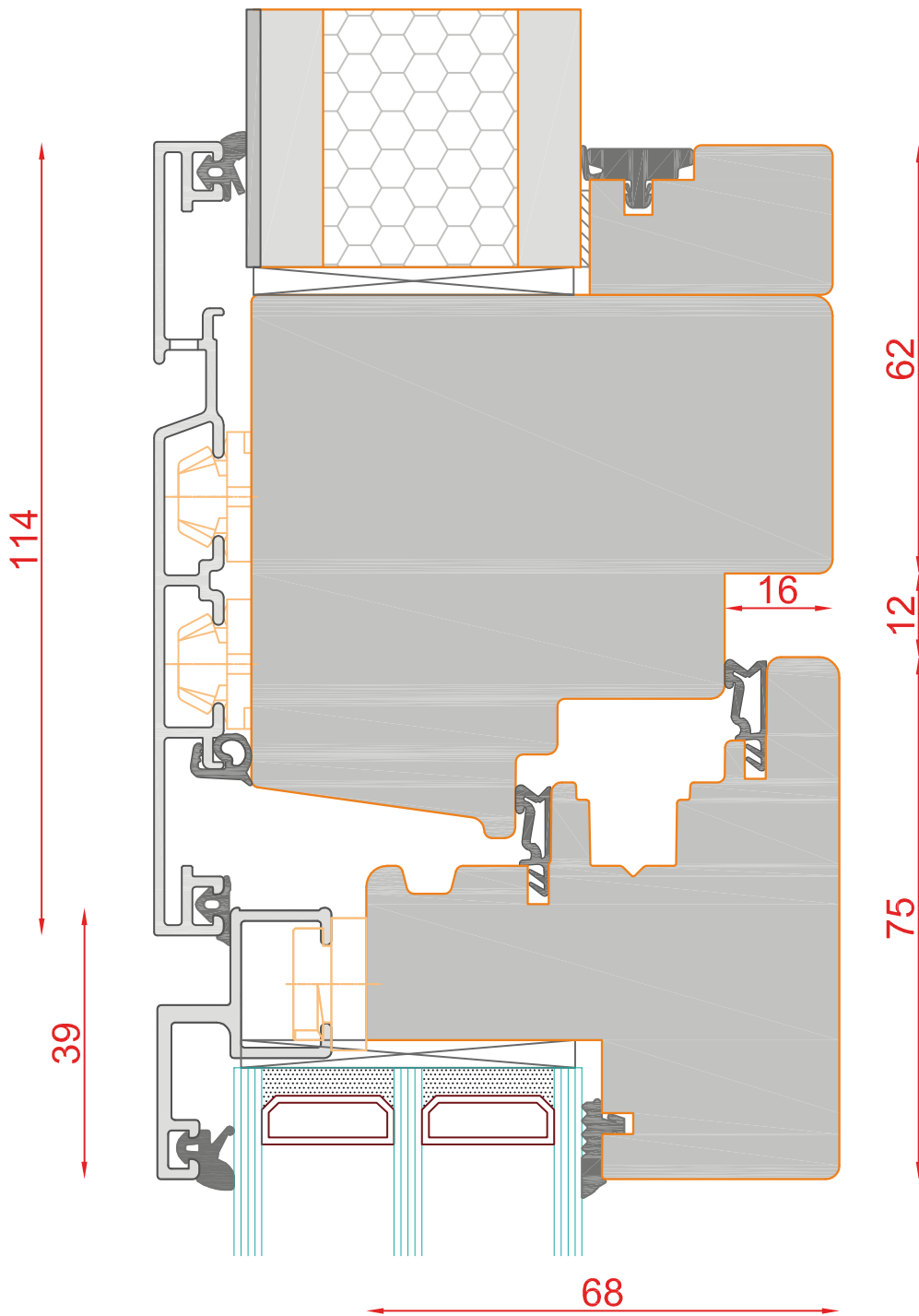

**DUO 100**  
PLANO

Schnitt : Vertikal Kämpfer DK-FIB

Typ: Füllung

| Seite: 226

**SCHMIDT VISBEK**  
Fenster. Türen. Innovationen.

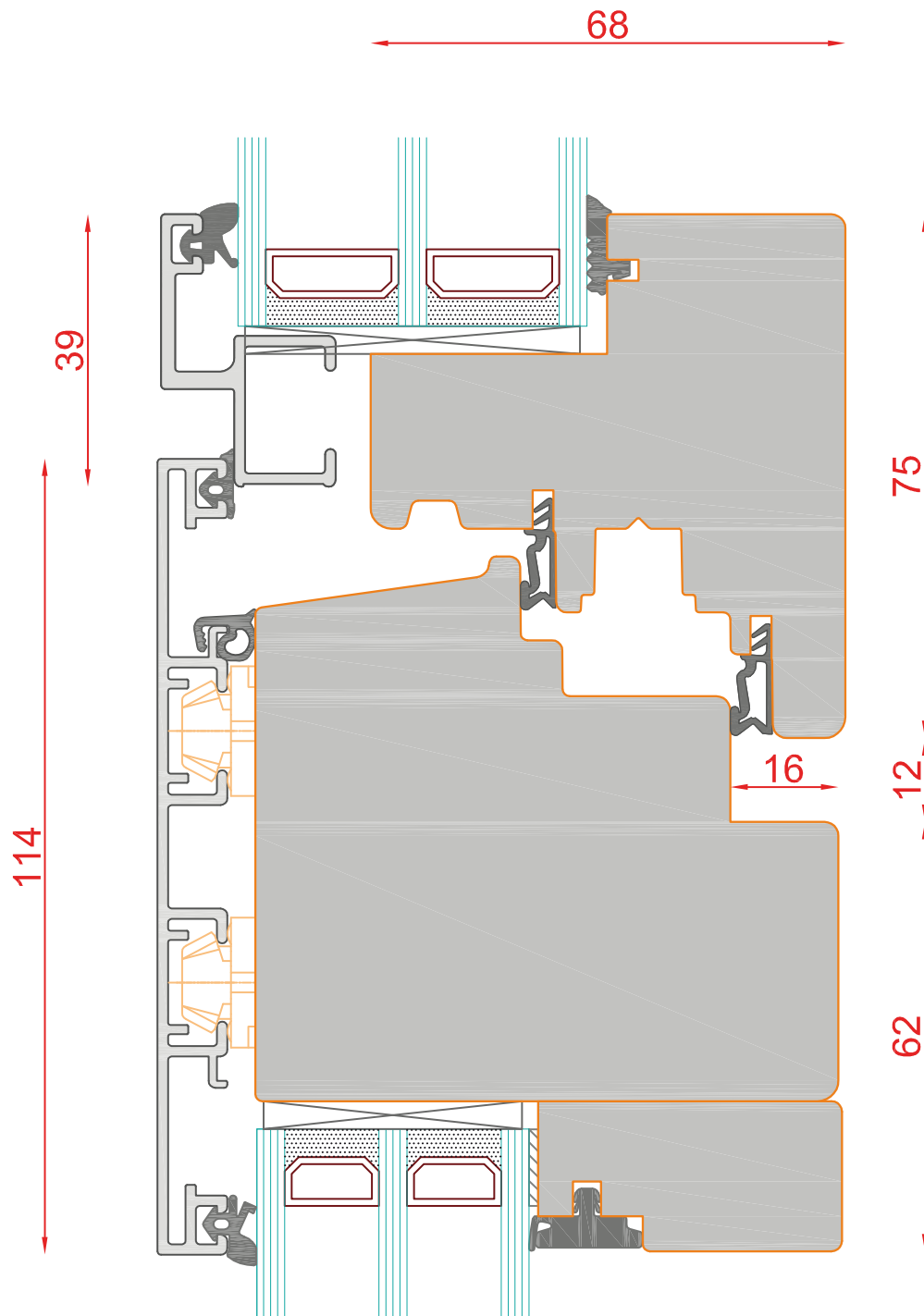
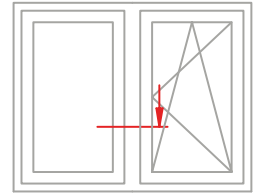

**DUO 100**  
PLANO

Schnitt : Horizontal Mitte

Typ: DK - FIB

| Seite: 227

**SCHMIDT VISBEK**  
Fenster. Türen. Innovationen.



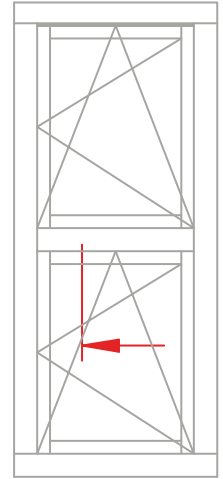
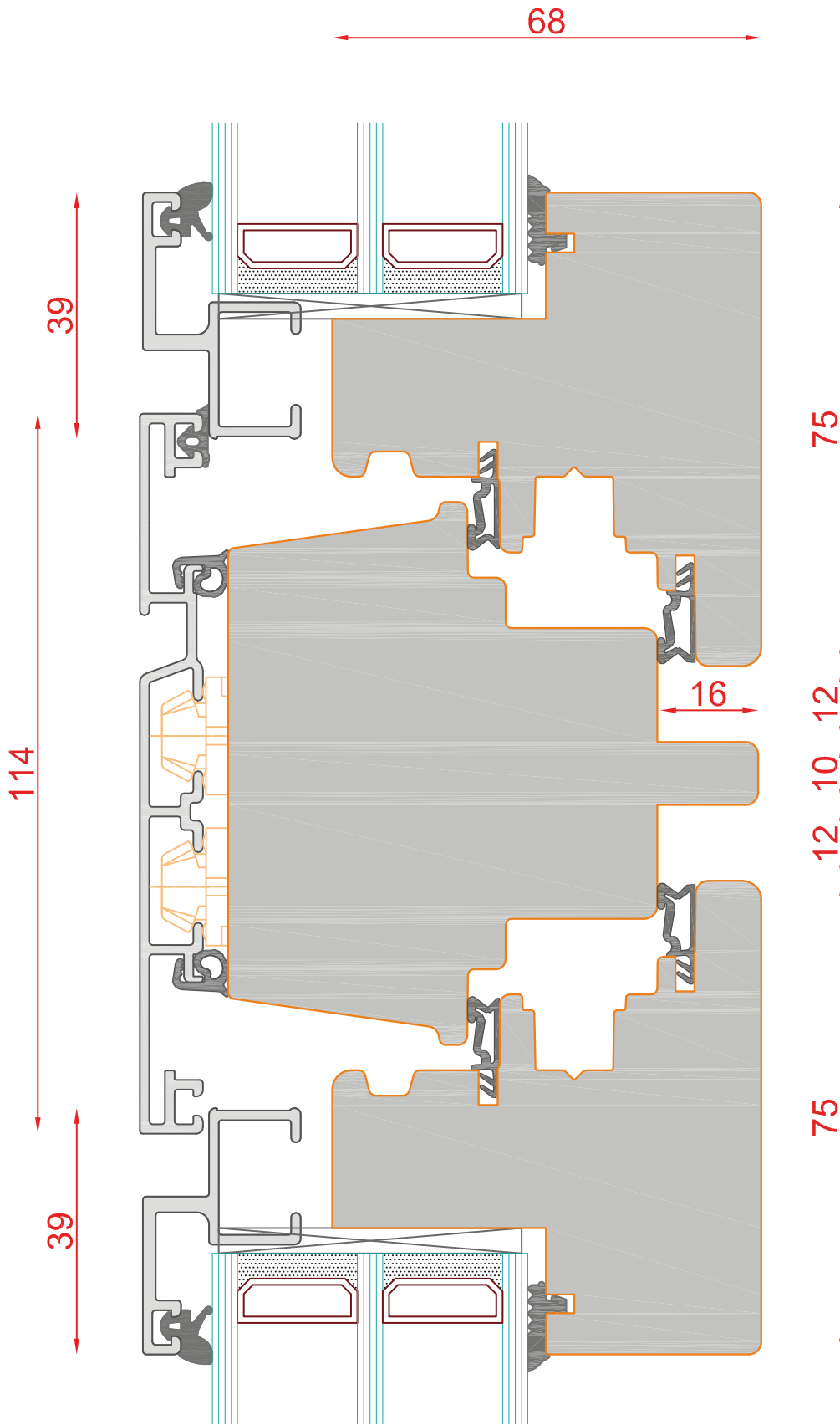

**DUO 100**  
PLANO

Schnitt : Vertikal

Typ: Kämpfer DK - DK

| Seite: 228

**SCHMIDT VISBEK**  
Fenster. Türen. Innovationen.



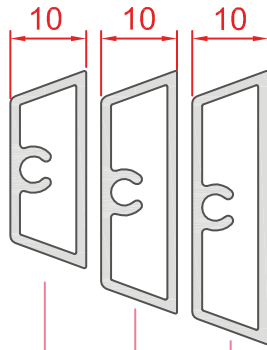

SP 36.10 = 36mm  
 SP 32.10 = 32mm  
 SP 26.10 = 26mm

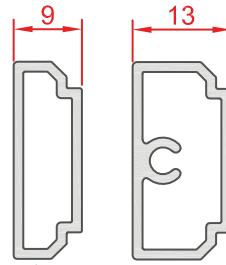

SP 26.13-SK = 26mm  
 SP 26.9-SK = 26mm

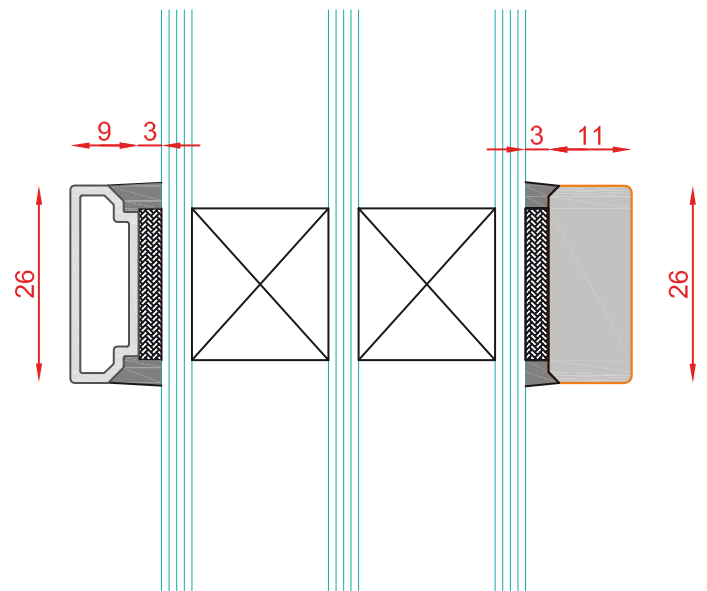
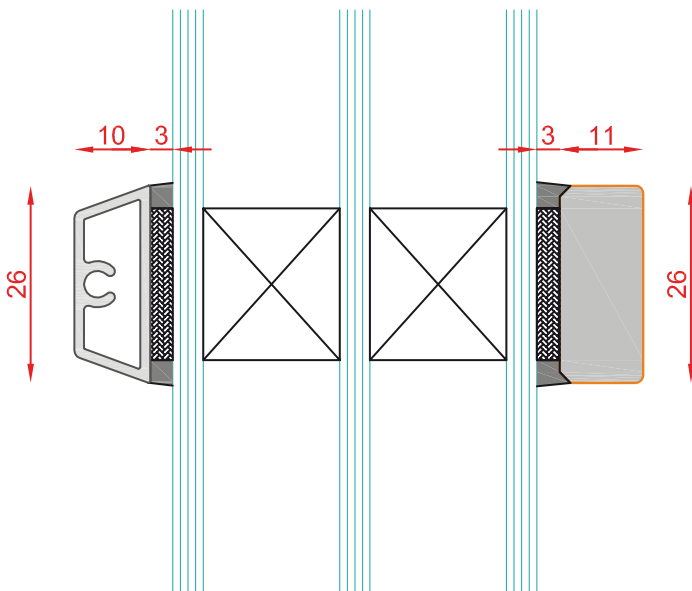
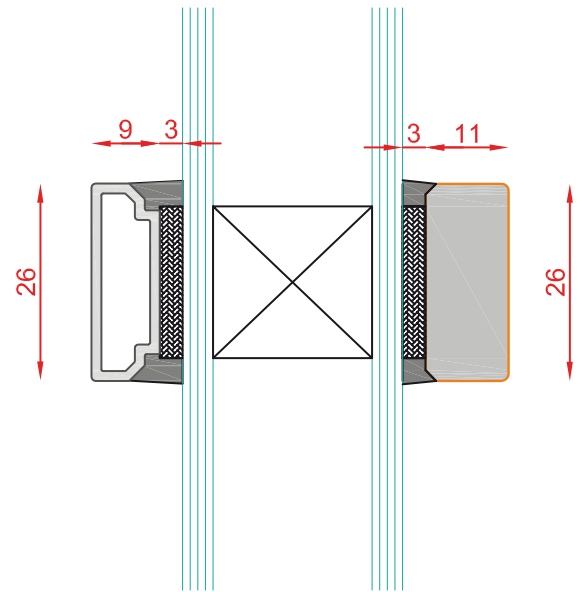
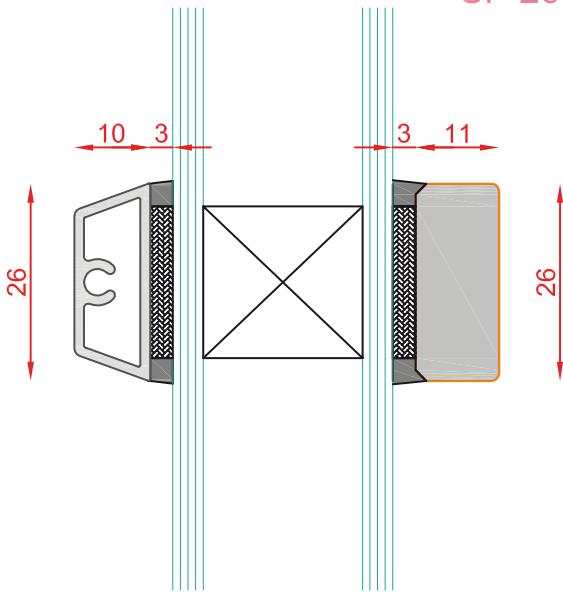

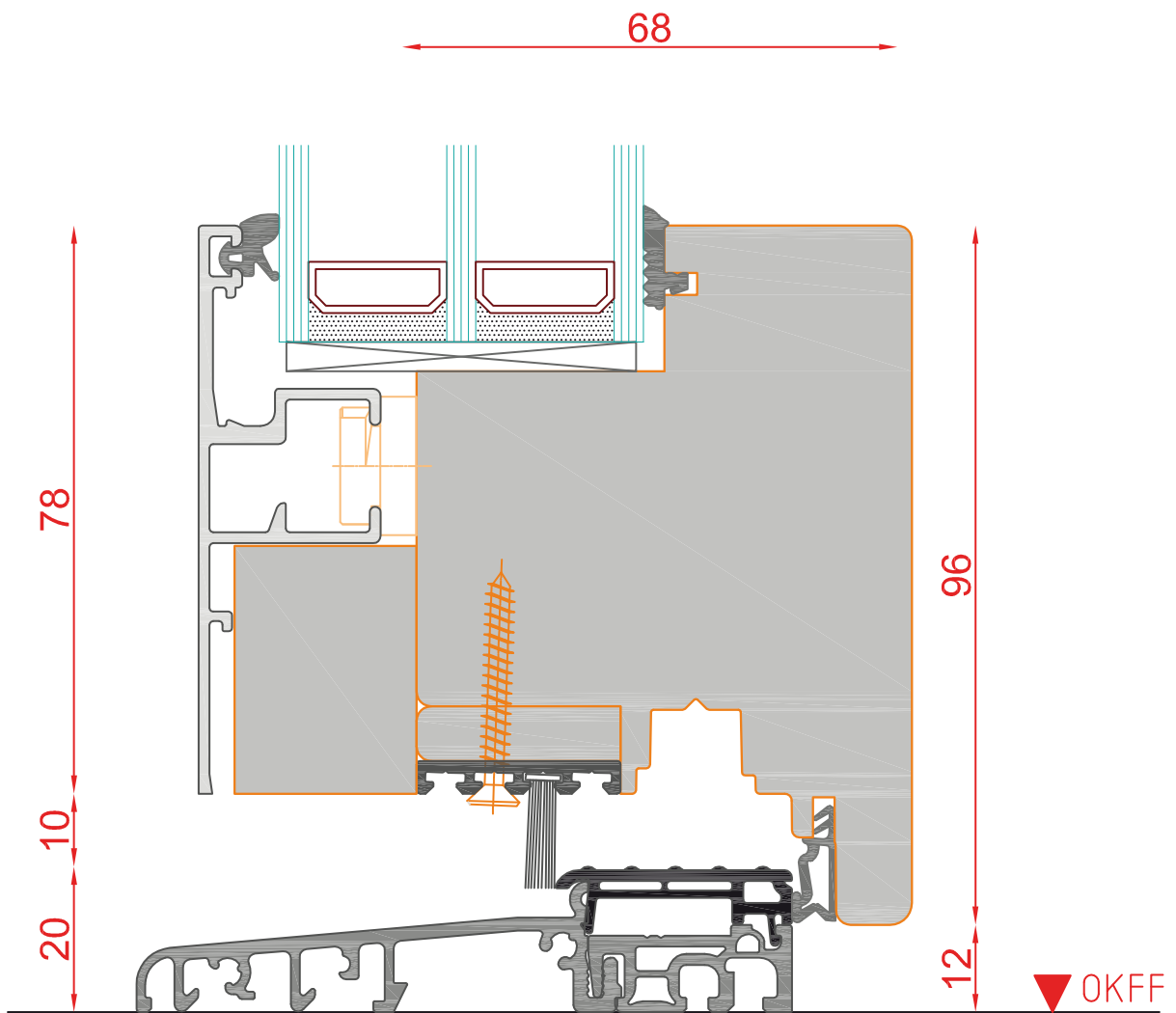
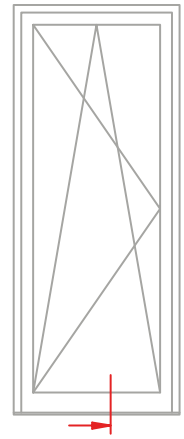

Bodenschwelle BKV Eifel 90 TB



DUO 100  
PLANO

Schnitt : Vertikal unten

Eifel Schiene 20mm

| Seite: 230

**SCHMIDT VISBEK**  
Fenster. Türen. Innovationen.

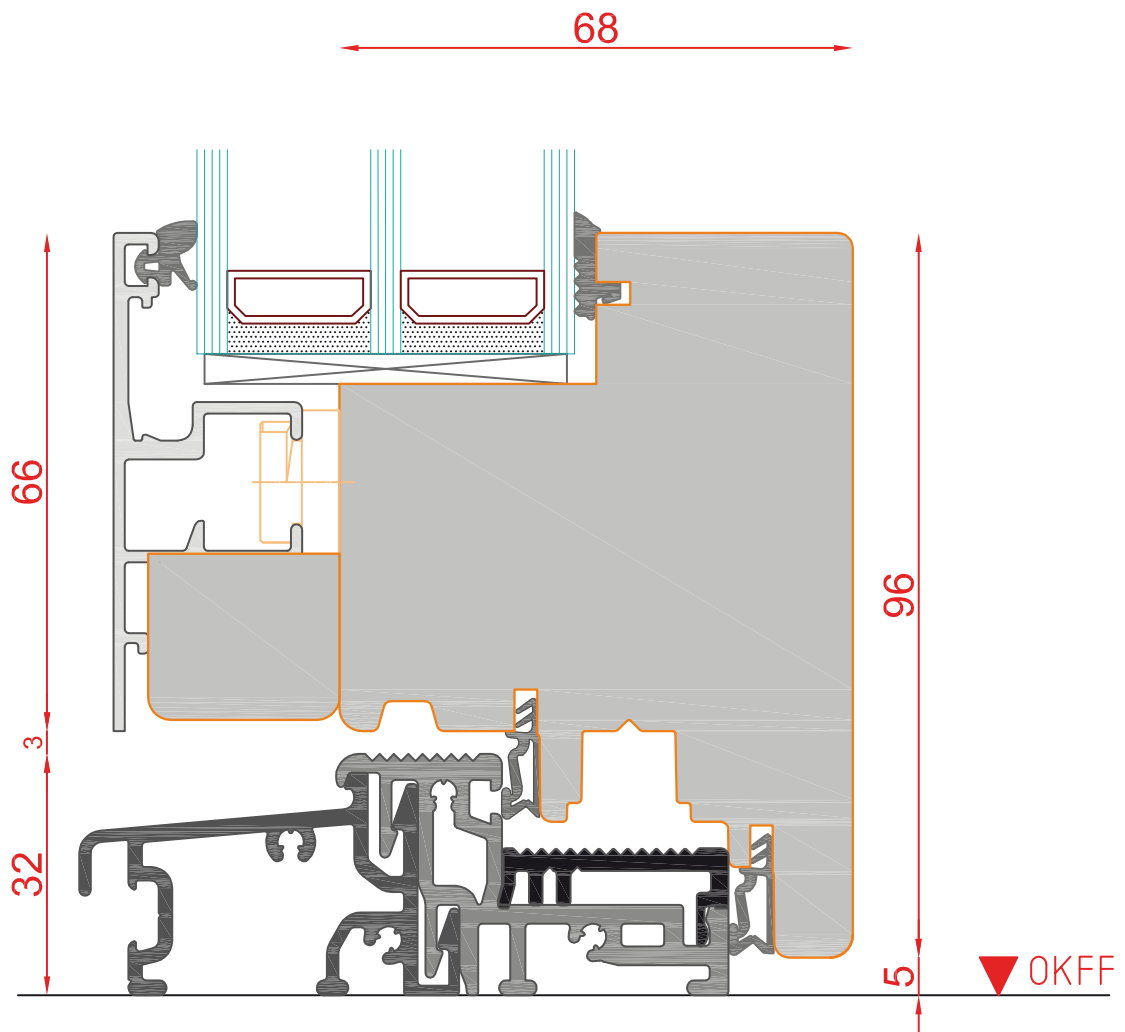
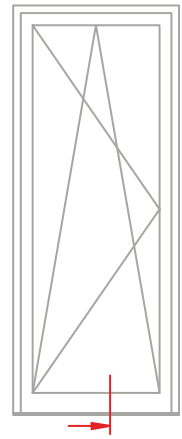

Bodenschwelle Weser 86/32 Ti



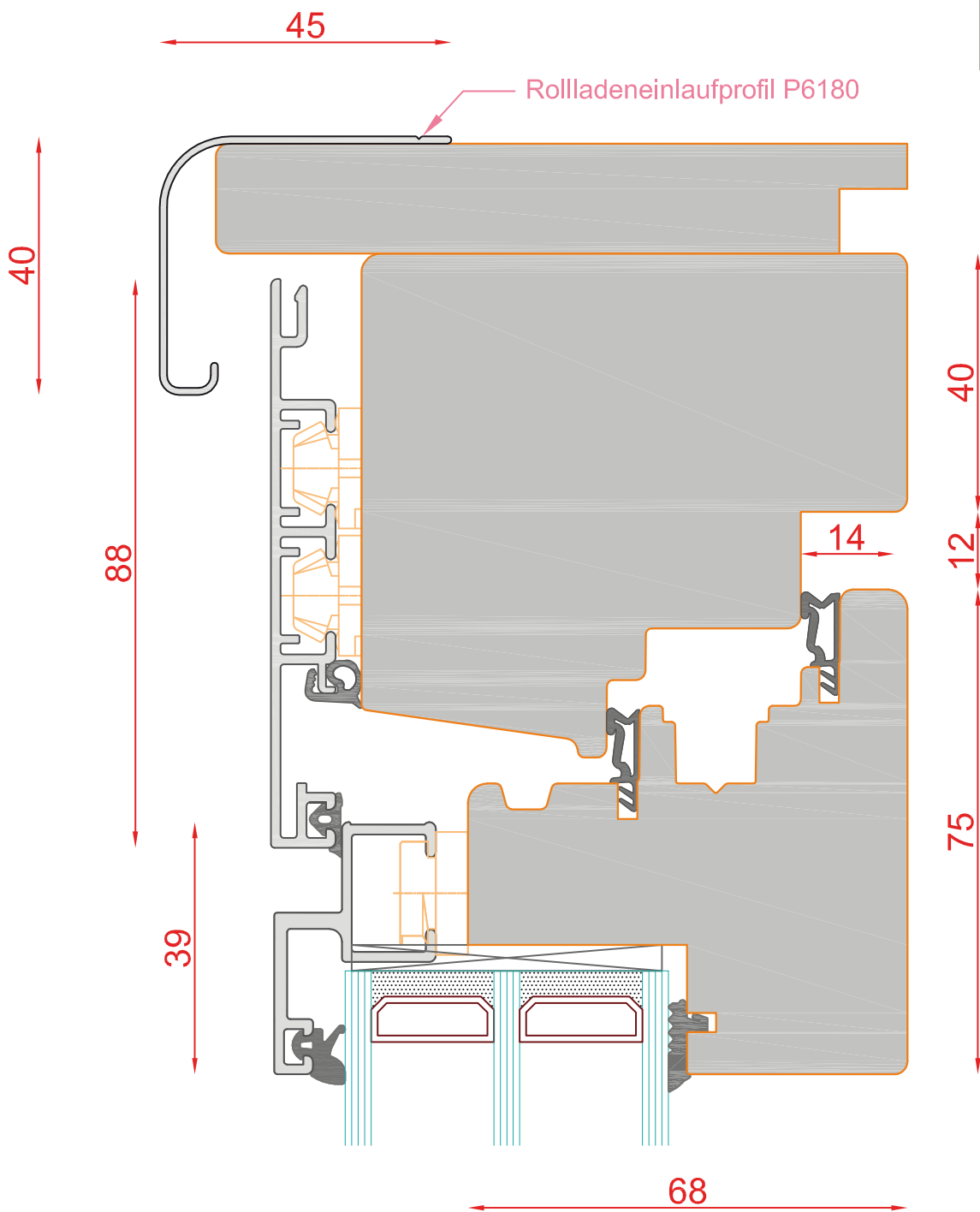
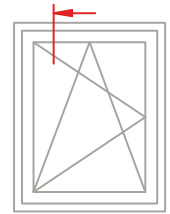

**DUO 100**  
PLANO

Schnitt : Horizontal seitlich und oben

Typ: DK

| Seite: 232

**SCHMIDT VISBEK**  
Fenster. Türen. Innovationen.

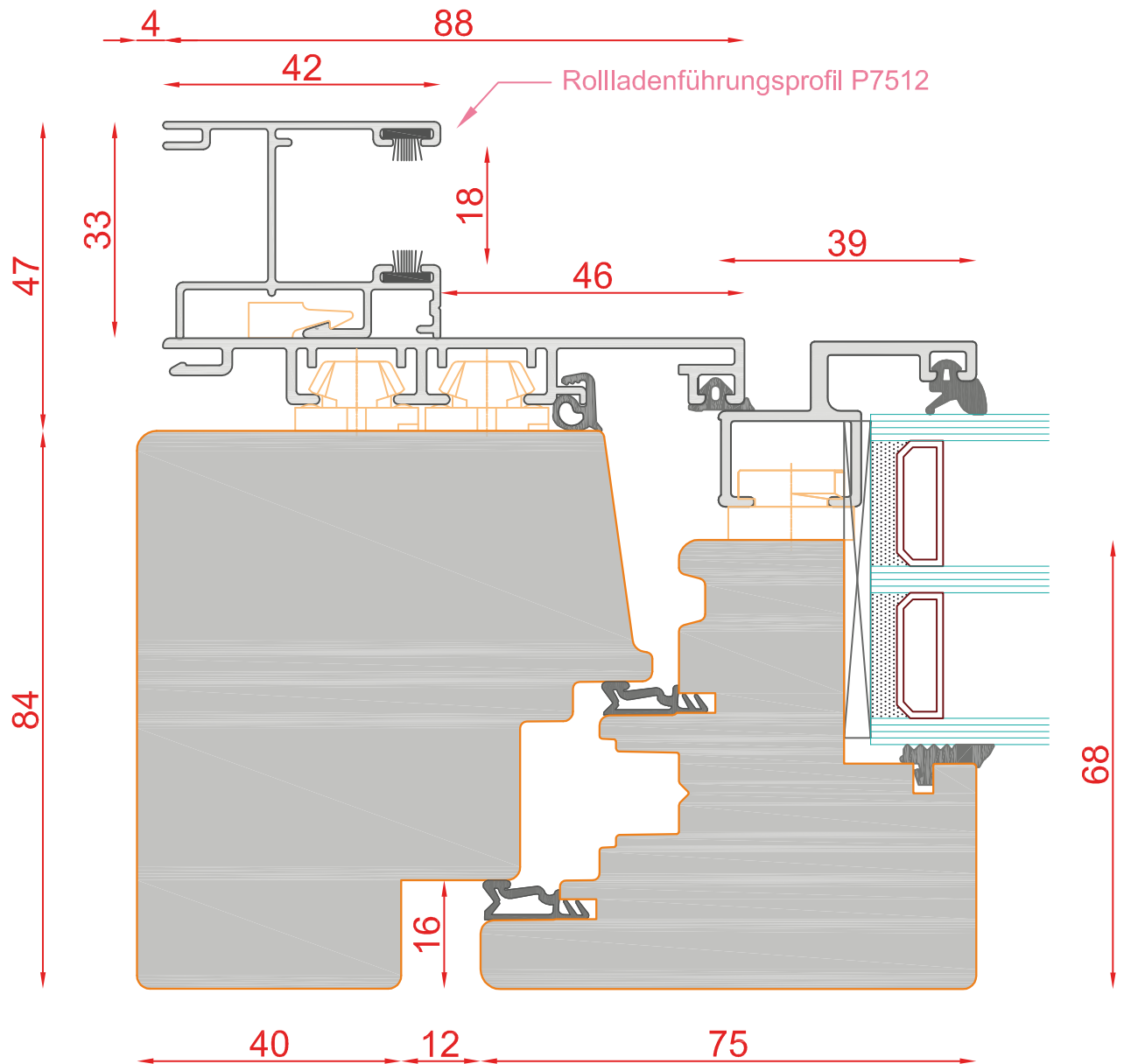
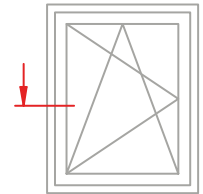

**DUO 100**  
PLANO

Schnitt : Horizontal seitlich und oben

Typ: DK

| Seite: 233

**SCHMIDT VISBEK**  
Fenster. Türen. Innovationen.

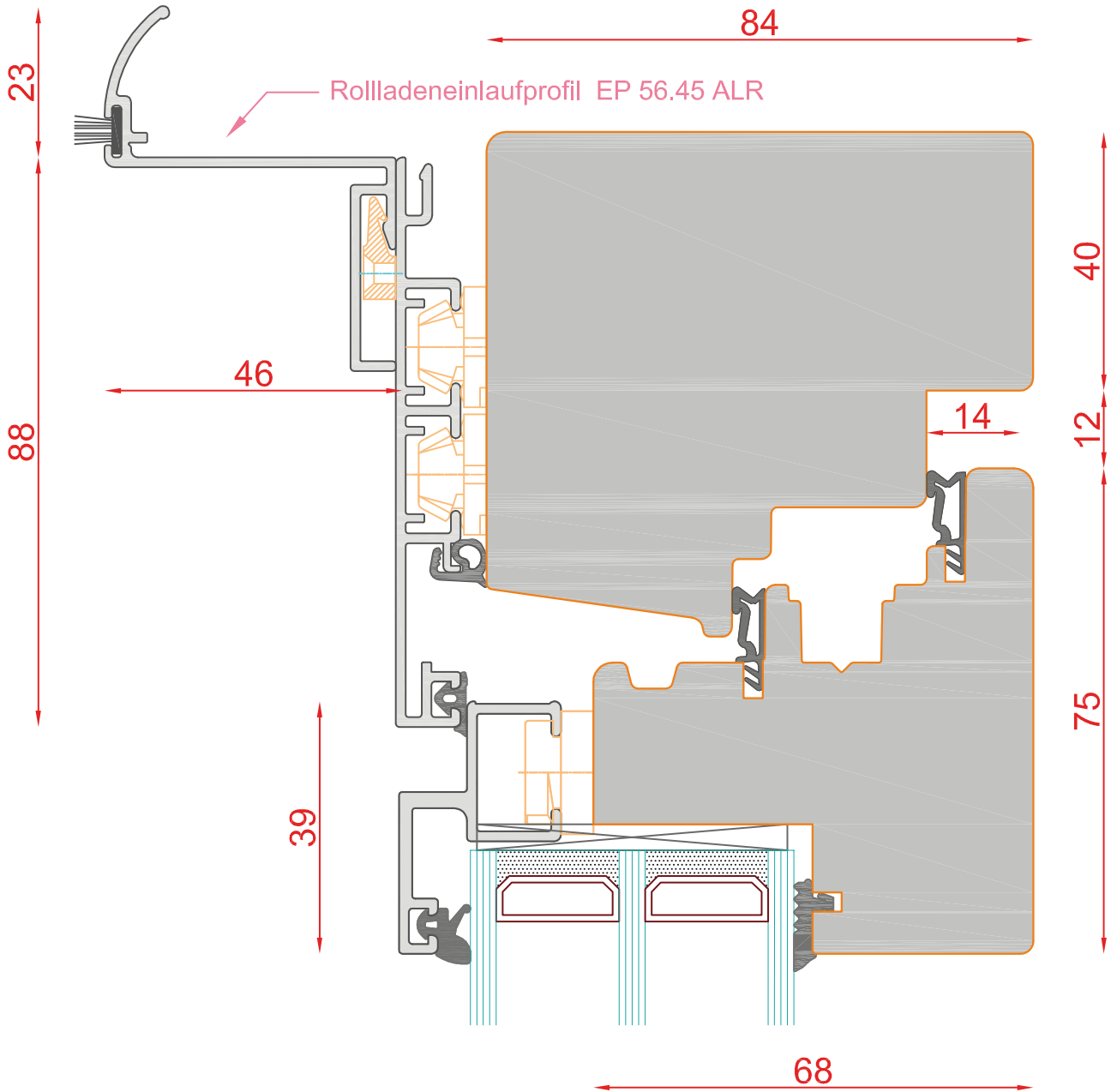
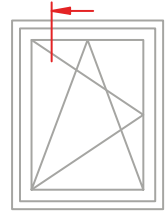

DUO 100  
PLANO

Schnitt : Horizontal seitlich und oben

Typ: DK

| Seite: 234

**SCHMIDT VISBEK**  
Fenster. Türen. Innovationen.

